

**READ THIS MANUAL BEFORE OPERATING YOUR SCOOT-N-GO™**

**ELECTRA ACCESSORIES, INC. STRONGLY SUGGESTS THE OPERATOR OF THIS PRODUCT BE 16 YEARS OF AGE OR OLDER.**

**SCOOT-N-GO™**

**ELECTRIC SCOOTER**

**Assembly and User's Manual**

Model#: 88700 / 88701 / 88702 / 88703 / 88705 / 88615



For the most recent version of this user's manual and for all updated product information please visit [www.electrausa.com](http://www.electrausa.com) or call Electra Customer Service / Technical Support Toll-Free Number at:

**1-888-467-1234**

M-F 10am - 9pm EST

**NEITHER ELECTRA ACCESSORIES NOR THE RETAIL SELLER OF THE SCOOT - N - GO™ IS RESPONSIBLE FOR THE CONSEQUENCES OF FAILURE TO COMPLY WITH STATE AND LOCAL ORDINANCES. THIS SCOOTER IS NOT INTENDED FOR USE ON PUBLIC STREETS OR HIGHWAYS. CHECK WITH DMV AND WITH LOCAL AND STATE LAWS AS YOUR CITY, MUNICIPALITY OR STATE MAY PROHIBIT THEIR USE.**

Electra Accessories Inc.  
2 Corporate Drive  
Cranbury, New Jersey 08512 USA  
website: [www.electrausa.com](http://www.electrausa.com)

**ELECTRA™**  
ACCESSORIES, INC.

**YOUR INSURANCE POLICIES MAY NOT PROVIDE COVERAGE FOR ACCIDENTS INVOLVING THE USE OF THE SCOOT - N - GO™. TO DETERMINE IF COVERAGE IS PROVIDED YOU SHOULD CONTACT YOUR INSURANCE COMPANY OR AGENT.**

# TABLE OF CONTENTS

## Features and Specifications

Motor, Battery, Performance, Tires \_\_\_\_\_ 3

**Contents of the Box** \_\_\_\_\_ 4

**General Safety Guidelines & Restrictions** \_\_\_\_\_ 5,6,7,8

## Assembly Instructions

Front Wheel Installation \_\_\_\_\_ 9

Handlebars Installation \_\_\_\_\_ 10

Throttle & Controls Installation \_\_\_\_\_ 10

Seat Installation \_\_\_\_\_ 11

Fuse Installation \_\_\_\_\_ 11

## Pre-Ride Adjustments

Brakes \_\_\_\_\_ 12

Tires/Wheel \_\_\_\_\_ 13

Drive Chain \_\_\_\_\_ 14

## Battery

Charging \_\_\_\_\_ 15

## Starting Instructions

Keys & Ignition \_\_\_\_\_ 16

## Service & Maintenance

Drive Chain \_\_\_\_\_ 16

Brakes \_\_\_\_\_ 16

Tires \_\_\_\_\_ 16,17

Battery \_\_\_\_\_ 17

**Storage** \_\_\_\_\_ 18

**Trouble Shooting** \_\_\_\_\_ 19

**Replacement Parts** \_\_\_\_\_ 19

**Wiring Diagram** \_\_\_\_\_ 20

**30 Day Limited Warranty** \_\_\_\_\_ 21

**Warranty Limitations** \_\_\_\_\_ 21

**Warranty Service Options** \_\_\_\_\_ 22

**Return Policy** \_\_\_\_\_ 23

**Notes** \_\_\_\_\_ 24

# FEATURES & SPECIFICATIONS

## Motor

- Output: 250W
- Voltage: 24V DC
- Rated current: 14.0A
- Non-loading rotate speed:  $3350 \pm 5\%$
- Rated rotate speed: 2500 RPM
- Rated torsion: 0.90

## Battery

- 12V 12Ah/5hr x (2) Qty
- Sealed lead acid

## Performance

- Maximum speed: 11 MPH
- Range: Nine (9) miles
- Incline rating: 40
- Net Weight: 45 lbs.
- Maximum load cap.: 178 lbs.

## Tires

- Tire Size: 2 1/4" x 12 1/2"
- Tire Pressure: 45-50 PSI



## CONTENTS OF BOX

- One (1) SCOOT - N - GO™
- User/assembly manual
- Tool kit containing 2 open ended wrenches, combination Phillips/Flathead head screwdriver
- Spare fuses (30 Amp x 3 qty)
- 24V Battery charger



**SCOOT - N - GO™**



**Manual**



**Charger**



**Tool Kit**

# GENERAL SAFETY GUIDELINES & RESTRICTIONS

This Manual contains many notes concerning the consequences of failure to maintain or inspect your SCOOT - N - GO™. Your safety and the safety of others is very important. We have provided important safety messages in this manual and on the SCOOT - N - GO™. Please read these messages carefully. A safety message alerts you to potential hazards that could hurt you or others. Each safety message is preceded by a safety alert symbol and one of two words.

## **⚠ WARNING**

You **CAN be SERIOUSLY HURT or KILLED if you don't follow instructions.** Failure to follow the instructions following it may result in injury to the rider or others during use, which may include losing control and falling. Because any fall can result in serious injury or even death, we do not repeat the warning of possible injury or death whenever the risk of falling is mentioned

## **⚠ CAUTION**

**Failure to follow the instructions following it may result in damage to the SCOOT - N - GO™ or component during assembly or use. (I.e. risk of property (product) damage only)**

### **CHECK STATE & LOCAL LAWS**

Your state department of motor vehicles (DMV), or the city or county where it will be used, may regulate the use of devices like the SCOOT - N - GO™. Some states may require a driver's license or minimum age to use the SCOOT - N - GO™, or require the SCOOT - N - GO™ to be registered or licensed or require some additional type of equipment like a brighter headlight. Please check with your state DMV or local municipality on requirements for using the SCOOT - N - GO™. They can be located in the phonebook. State DMV offices can also be located on the Internet at such sites as the following [www.dmv.org](http://www.dmv.org) or [www.statehousegirls.net/agencies/dmv](http://www.statehousegirls.net/agencies/dmv).

If your state or municipality allows the SCOOT - N - GO™ to be used on vehicle roadways please make sure you are familiar with all traffic laws as set forth by your state DMV, such as yielding to pedestrians and other motorists, signaling, riding as far to the right edge of the roadway as possible, obeying traffic signs etc. Your state DMV can provide you with materials setting forth these traffic laws.

### **In addition to those traffic laws abide by the following general principals:**

1. You are sharing the road or the path with others – motorists, pedestrians and other cyclists. Respect their rights, and be tolerant if they infringe on yours.
2. Ride defensively.
3. Look ahead of where you're going, and be ready to avoid:
  - \* Vehicles slowing or turning in front of you, entering the road or your lane ahead of you, or coming up behind you.
  - \* Parked car doors opening in front of you.
  - \* Pedestrians stepping out in front of you.
  - \* Children or dogs playing near the road.
  - \* Pot holes, sewer grating, railroad tracks, expansion joints, road or sidewalk construction, debris and other obstructions that could cause you to swerve into traffic, catch your wheel or otherwise cause you to lose control and have an accident.
  - \* The many other hazards and distractions which can occur while using the SCOOT - N - GO™ during a ride.
4. Ride on the right side of the road, in the same direction as vehicle traffic and as close to the edge of the road as possible.
5. Stop at stop signs and traffic lights; slow down and look both ways at street intersections. Remember that the SCOOT - N - GO™ will always lose in a collision with a motor vehicle, so be prepared to yield even if you have the right of way.
6. Use hand signals for turning and stopping. Learn the local vehicle code for the correct signals.
7. Don't weave through traffic or make any moves that may surprise people with whom you are sharing the road.
8. Never carry anything which obstructs your vision or your complete control of the SCOOT - N - GO™, or which could become entangled in the moving parts of the SCOOT - N - GO™.
9. Never hitch a ride by holding on to another vehicle.

**NEITHER ELECTRA ACCESSORIES NOR THE RETAIL SELLER OF THE SCOOT - N - GO™ IS RESPONSIBLE FOR THE CONSEQUENCES OF FAILURE TO COMPLY WITH STATE AND LOCAL ORDINANCES RELATING TO THE USE OF THE SCOOT - N - GO™**

## **⚠ WARNING**

### **CALIFORNIA PROPOSITION 65**

**THIS PRODUCT CONTAINS LEAD AND LEAD COMPOUNDS, CHEMICALS KNOWN TO THE STATE OF CALIFORNIA TO CAUSE CANCER AND REPRODUCTIVE HARM. WASH HANDS AFTER HANDLING.**

# GENERAL SAFETY GUIDELINES & RESTRICTIONS

## HELMET USE WHILE RIDING THE SCOOT - N - GO™

Your state DMV, or the city or county where it will be used, may require that you use a helmet that meets the federal Department of Transportation "DOT" requirements (like those used by motorcycle riders) while riding the SCOOT - N - GO™. Other states or municipalities may require that a helmet meet the Consumer Product Safety Commission (CPSC) helmet requirements (like those used by human powered bike riders) while riding the SCOOT - N - GO™. Even if your State or municipality has no requirements concerning helmet use, the SCOOT - N - GO™ should not be used under any circumstances without properly wearing a helmet that meets either the DOT or CPSC regulations. The helmet must have a label inside which indicates which regulation it meets. If you are unsure contact DOT at [www.nhtsa.gov](http://www.nhtsa.gov) (888-327-4236) or CPSC at [www.cpsc.gov](http://www.cpsc.gov) (800-638-2772).

### **⚠ WARNING**

#### **Follow Safety Guidelines:**

**\*Your safety and the safety of others is very important. We have provided important safety messages in this manual and on the SCOOT - N - GO™. Please read these messages carefully. A safety message alerts you to potential hazards that could hurt you or others.**

- *Never operate the SCOOT - N - GO™ without proper instructions.*
- *Never allow a child under the age of 16 to operate the SCOOT - N - GO™*
- *Failures to follow the warnings contained in this manual can result in serious injury or death.*
- *Read this manual and all warning labels carefully and follow the operating procedures as described.*
- *Do not operate the SCOOT - N - GO™ unless you are able to safely start, stop, turn, and yield to all obstacles in the environment.*
- *Follow all local and state laws for approved riding areas, rules and regulations.*
- *Never carry a passenger on the SCOOT - N - GO™.*
- *Never ride the SCOOT - N - GO™ on public streets, sidewalks, parking lots, highways, freeways, or at night.*
- *Never operate on excessively rough, slippery or loose terrain.*
- *Never operate downhill or uphill. Always operate on level surfaces*
- *Never operate at excessive speeds. Always go at a speed that is proper for the operating conditions and your experience.*
- *Never attempt wheelies, jumps, or other stunts.*
- *SCOOT - N - GO™ should not be ridden by any person weighing more than 178 lbs*
- *SCOOT - N - GO™ should not be ridden by any person shorter than 60"*
- *SCOOT - N - GO™ should not be ridden by any person with an inseam of less than 25"*

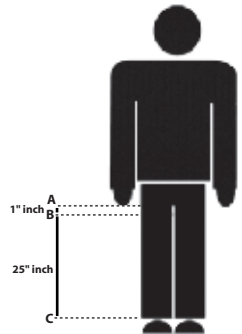

# GENERAL SAFETY GUIDELINES & RESTRICTIONS

## **⚠ WARNING**

- *SCOOT - N - GO™ should not be ridden by any person that is physically or mentally challenged*
- *SCOOT - N - GO™ should not be ridden by any person with vision, balance, hearing or coordination impairments*
- *SCOOT - N - GO™ should not be ridden by any person using headphones or a cellular phone (They mask traffic sounds and emergency vehicle sirens, distract you from concentrating on what's going on around you, and their wires can tangle in the moving parts of the SCOOT - N - GO™, causing you to lose control)*
- *SCOOT - N - GO™ should not be ridden by any person barefoot, wearing sandals, open toed, high heeled, platform or slip on footwear*
- *Never stand on a SCOOT - N - GO™ whether moving or not*
- *Always keep both hands on the handlebars and both feet on the footrest during operation.*
- *Always be alert to your surroundings while riding the SCOOT - N - GO™.*
- *Always follow proper procedures for turning as described in this manual. Do not turn at excessive speeds or make sudden or sharp turns.*
- *Always check for obstacles before operating the SCOOT - N - GO™ in a new area.*
- *Do not attempt to accelerate and have the brake on at the same time. [This may cause damage to the motor or drive train or cause the motor or drive train to overheat.]*
  
- *Never operate the SCOOT - N - GO™ without wearing an approved helmet that fits properly. You should also wear eye protection, gloves, closed-toe shoes, long-sleeved shirt or jacket, long pants, as well as elbow and kneepads*
- *Never consume drugs or alcohol before or while operating the SCOOT - N - GO™. Drugs or alcohol can impair your judgment and reaction time*
- *Before starting the SCOOT - N - GO™, check throttle control and brakes for proper operation*
- *Always inspect the SCOOT - N - GO™ each time you use it to make sure it is in safe operating condition. Check for loose screw, nuts, bolts, parts, brakes, drivechain, etc.*
- *Always follow the inspection and maintenance procedures described in this manual.*
- *Always use the size and type tires specified in this manual. Always maintain proper tire pressure as described in this manual. Type of tire and inflation can affect the SCOOT - N - GO™ handling*
- *Do not operate near flammable liquids or materials*
- *Never attempt to repair when ignition is on*
- *Keep all loose clothing away from drive chain*

## **⚠ WARNING**

**DO NOT MAKE ANY ALTERATIONS OR MODIFICATIONS TO THE SCOOT - N - GO™, OR ADD ANY PARTS NOT AUTHORIZED BY ELECTRA EXCEPT THOSE DISCUSSED IN THIS MANUAL OR THOSE REQUIRED BY LAW. DO NOT REMOVE ANY REFLECTORS, LIGHTS OR OTHER STANDARD EQUIPMENT. FAILURE TO FOLLOW THESE OPERATION INSTRUCTIONS CAN RESULT IN SERIOUS INJURY OR DEATH OR COULD RESULT IN AN ELECTRICAL SHORT AND OR FIRE.** All authorized replacement parts are available at [www.electraUSA.com](http://www.electraUSA.com) or by calling Electra customer service a 1-888-467-1234 M-F 10am - 9pm EST.

**NEITHER ELECTRA ACCESSORIES NOR THE RETAIL SELLER OF THE SCOOT - N - GO™ IS RESPONSIBLE FOR THE CONSEQUENCES OF FAILURE TO COMPLY WITH STATE AND LOCAL ORDINANCES RELATING TO THE USE OF THE SCOOT - N - GO™**



## GENERAL SAFETY GUIDELINES & RESTRICTIONS

### **⚠ WARNING** **⚠ CAUTION**

#### **BEFORE EACH RIDE:**

- ***Make sure you properly (per the instructions in the helmet) wear a helmet that meets DOT or CPSC regulations***
  - ***Wear protective clothing and gloves***
  - ***Wear eye protection that does not interfere with your peripheral vision***
  - ***Make sure SCOOT - N - GO™ is fully charged***
  - ***Make sure the horn, turn signals and headlight are operational***
  - ***Make sure the brake is properly adjusted and working correctly***
  - ***Make sure you understand how the brake works and that your hands can reach and squeeze the brake lever comfortably and hard enough to stop the SCOOT - N - GO™ safely.***
  - ***Make sure the chain is properly adjusted***
  - ***Make sure all screw, nuts, bolts and parts of the SCOOT - N - GO™ are properly and securely fastened and adjusted.***
  - ***Make sure the tires are not excessively worn, do not have tears or cuts, and are properly seated on the rim and inflated properly***
  - ***Make sure the wheels spin straight and that the rims are not bent or damaged***
- \*REFER TO MANUAL FOR DETAILED INSTRUCTIONS**

### **⚠ WARNING** **⚠ CAUTION**

#### **AFTER EACH RIDE:**

- ***Make sure that the ignition key is turned off and that all keys are removed and kept in a safe place.***
  - ***Make sure the throttle is rotated to the off position.***
  - ***Ensure that the kickstand is used so the SCOOT - N - GO™ will not fall over and get damaged.***
  - ***Ensure the SCOOT - N - GO™ is not kept outdoors or where moisture can damage it.***
  - ***Do not charge or store the SCOOT - N - GO™ closer than 20 feet from any flame (e.g. furnace, fireplace, water heater, space heater)***
  - ***Do not allow children under 16 to play on or near the unattended SCOOT - N - GO™.***
- \*REFER TO MANUAL FOR DETAILED INSTRUCTIONS**

# ASSEMBLY INSTRUCTIONS

## ⚠ CAUTION

**BEFORE ASSEMBLING YOUR SCOOT-N-GO™, PLEASE BE SURE YOU HAVE ALL NECESSARY PARTS. REFER TO PAGE #4. PLEASE FOLLOW PROPER ASSEMBLY INSTRUCTIONS. IF YOU DO NOT HAVE THE PROPER PARTS NECESSARY TO ASSEMBLE YOUR SCOOT-N-GO™, PLEASE DO NOT RETURN THE UNIT TO THE ORIGINAL PLACE OF PURCHASE. CALL ELECTRA CUSTOMER SERVICE AT: 1-888-467-1234 M-F 10am - 9pm EST.**

1. Remove scooter from carton and all protective materials from the unit.
2. Use tool kit provided for installation

### FRONT WHEEL INSTALLATION:

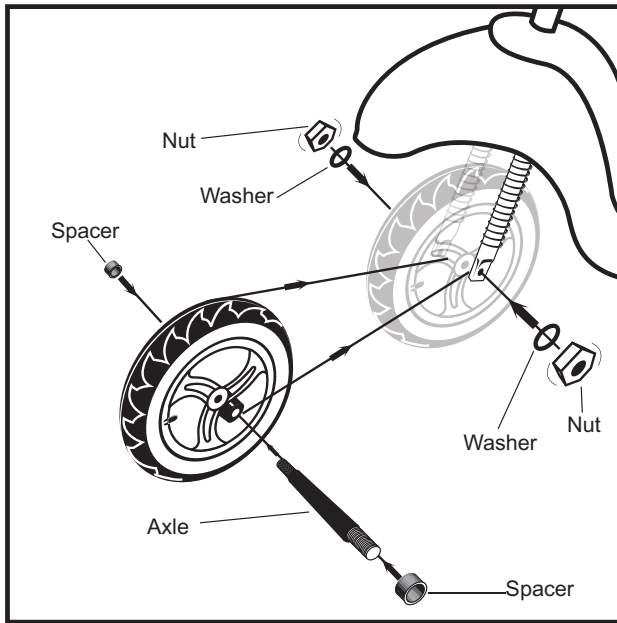

### Parts Needed

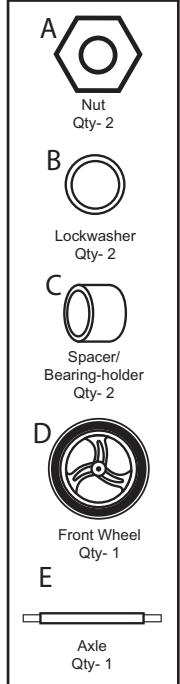

\*Photos are not to scale

1. Place wheel (D) in the center of the forks
2. Insert one (1) spacer (C) between wheel (D) and fork
3. Carefully insert axle (E) through fork, spacer (C), and wheel (D)
4. Insert one (1) spacer (C) on opposite side between fork and wheel (D)
5. Continue to insert axle (E) through fork on opposite side
6. Place washers (B) and nuts (A) on both ends of axle and tighten with open ended wrench provided in the tool kit.
7. Check nuts are tight and wheel moves freely

# ASSEMBLY INSTRUCTIONS

**⚠ WARNING** **⚠ CAUTION**

## HANDLEBARS INSTALLATION:

1. Insert handlebar post through tightening clamp
2. Insert the top of the fork base into bottom of handlebar post.
3. Line up handlebars and front wheel
4. Slide tightening clamp down to open end of fork base
5. Insert bolt and hand tightening nut into clamp and tighten.
6. Be sure that handlebars and wheel move at the same time.

\* Tightening Clamp must line up with the opened end of the fork base

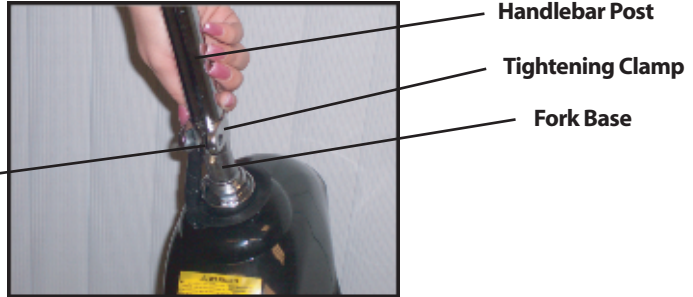

Fig. 1

## THROTTLE & ACCESSORY CONTROL GRIP INSTALLATION:

1. Insert throttle into handle bars and secure with tightening screw. (Fig. 2)
2. Insert accessory control grip and secure with tightening screw. (Fig. 3)
3. Be sure screws, throttle and accessory control grip are secure and not loose.

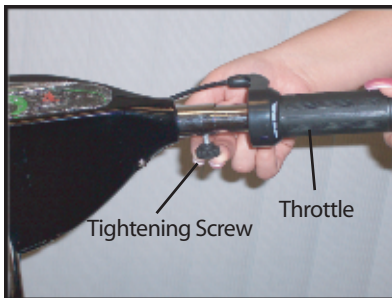

Fig. 2



Fig. 3

# ASSEMBLY INSTRUCTIONS

**⚠ WARNING** **⚠ CAUTION**

## SEAT INSTALLATION:

1. Insert tapered end of seat post into seat and tighten both seat brackets.
2. Place tightening clamp around the chassis base, insert seat post, adjust for the proper height of the rider, and tighten clamp.
3. Be sure seat is facing the front of the scooter and it does not move.

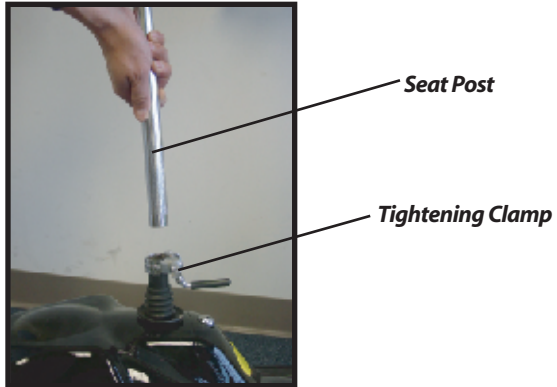

Fig. 4

## INSERT FUSE:

1. Remove fuse cap
2. Insert fuse into fuse cylinder and Rescrew cap (Fig. 5)
3. Do not stick any objects other than the fuse into fuse cylinder.

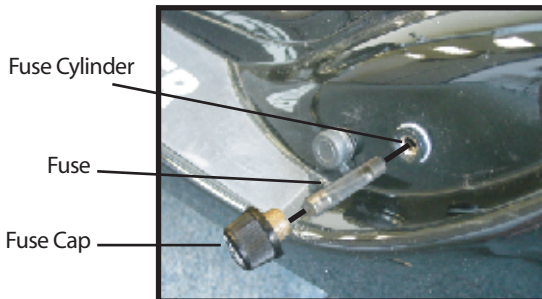

Fig. 5

Continued on Next Page

# PRE-RIDE ADJUSTMENTS

## **⚠️ WARNING** **⚠️ CAUTION**

**THE REAR BRAKE ON YOUR SCOOT - N - GO™ HAS BEEN PRE-ASSEMBLED AND PRE-ADJUSTED BY THE MANUFACTURER.**

**HOWEVER, THE CABLE AND BRAKE MAY NEED ADJUSTMENT IF IT IS NOT SLOWING OR STOPPING THE SCOOT - N - GO™ PROPERLY. THE BRAKE CAN BE ADJUSTED AT TWO POINTS ON THE THE SCOOT - N - GO™. ONE ADJUSTING SCREW IS AT THE REAR WHEEL AND OTHER IS AT THE BRAKE LEVER.**

### REAR BRAKE ADJUSTMENT:

1. Determine brake lever has proper slack
  - \*Brake lever cannot be too tight or it can snap the cable!
  - \*Brake lever cannot be too loose or your SCOOT - N - GO™ may not stop correctly
2. To adjust slack, rotate brake adjustment knob to desired position.  
Check slack by engaging the brake lever. (FIG. 2)
  - \*Proper slack should be similar to FIG. 1 (A properly adjusted brake lever should leave approximately 1" - 1 1/4" between the brake lever and throttle grip)
3. If desired slack is achieved, rotate the locking nut clockwise until tight.
4. To adjust rear brake, locate adjustment screw at the rear wheel.
5. Loosen or tighten screw for proper adjustment. Rotate 3 to 4 times, and then check for desired tension by rolling the scooter forward and engaging the brake.
6. If desired brake tension has been achieved, rotate the locking nut clockwise until tight.
7. Rear wheel should not roll when brake is engaged.



FIG. 1



FIG. 2

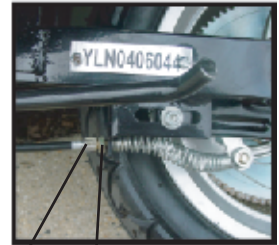

FIG. 3

## **⚠️ WARNING** **⚠️ CAUTION**

**IF THE PROPER TENSION IS STILL NOT ACHIEVED, CHECK THE BRAKE AND CABLE TO ENSURE EVERY PART IS PROPERLY CONNECTED. DAMAGED OR FAULTY BRAKE COMPONENTS (CABLE, BRAKE ASSEMBLY) WILL NOT ALLOW FOR THE SCOOTER TO STOP PROPERLY AND SHOULD BE REPLACED IMMEDIATELY TO AVOID ANY SERIOUS INJURIES TO THE USER OR OTHERS. REPEAT PROCEDURE UNTIL DESIRED TENSION IS ACHIEVED.**

Periodically check the control cables, cable housings, and brake lever. Any rust? Kinks? Fraying? If so, DO NOT ride the SCOOT - N - GO™. Call Electra customer service at 1-888-467-1234 M-F 10am - 9pm EST or visit your local bicycle dealership and have them adjusted or replaced.

Continued on Next Page

# PRE-RIDE ADJUSTMENTS

## TIRE ADJUSTMENTS:

### IMPORTANT INFORMATION!!!

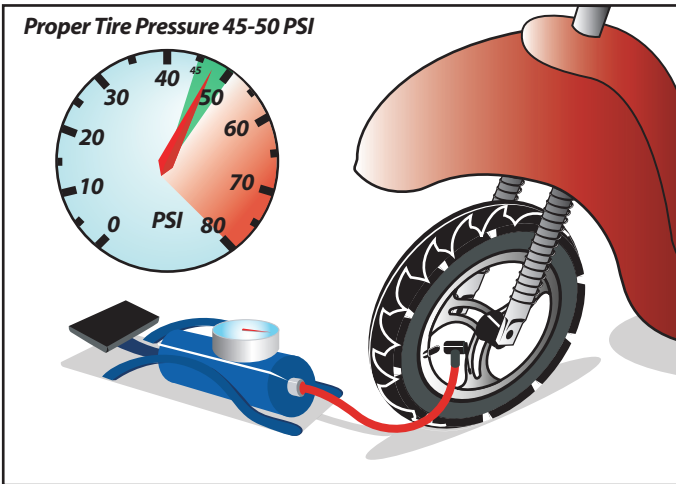

*Make sure that the air pressure for all tires is between 45-50 PSI . If the tires have less than the recommended amount of pressure, a decrease in battery usage time, poor handling, and damage to the tires and rims may occur. Use an air pressure gauge to check for the air pressure of the tire.*

### **⚠ WARNING** **⚠ CAUTION**

**DO NOT USE GAS STATION AIR FILLING STATIONS AS THE PRESSURE IS USUALLY TOO HIGH AND THE GAUGES ARE INACCURATE. OVER INFLATION OF THE TIRE COULD CAUSE A BLOW OUT AND CRASH.**

## WHEEL ADJUSTMENTS/MAINTANENCE:

1. *Wheels should rotate straight and freely*
2. *A lubricant or oil should be applied to the wheel bearings monthly or more often if ridden in extremely wet or dusty conditions.*



Periodically check tires, wheels, bearings, and cables. Any rust? Kinks? Fraying? If so, DO NOT ride the SCOOT - N - GO™. Call Electra customer service at 1-888-467-1234 M-F 10am - 9pm EST or visit your local bicycle dealership and have them adjusted or replaced.

# PRE-RIDE ADJUSTMENTS

## DRIVE CHAIN ADJUSTMENTS

### CHECKING CHAIN TENSION:

1. Make sure key is not in ignition
2. Lay bike on its side to check drive chain
3. Squeeze chain using your thumb and index finger to determine if chain is too loose or too tight. (FIG. 1)
4. Also move chain side by side to check if chain could jump of sprocket teeth.
5. Chain should not move passed sprocket teeth when moving side by side. (FIG. 2)

### TIGHTEN DRIVE CHAIN:

1. Loosen the rear axle nuts (counter clockwise)
2. Tighten the chain adjustment eye bolts (clockwise) evenly so that the rear wheel doesn't become misaligned.
3. Once the proper drive chain tension has been achieved, tighten the axle nuts (clockwise).

### ⚠ CAUTION

**CHAIN MUST HAVE NO LESS THAN AND NO MORE THAN A 1/4" OF MOVEMENT.  
IF CHAIN IS TOO TIGHT, IT CAN BREAK AND CAUSE SERIOUS INJURY**

### LOOSEN DRIVE CHAIN:

1. Loosen the rear axle nuts (counter clockwise).
2. Loosen the chain adjustment eye bolts (counter clockwise) evenly so that the rear wheel doesn't become misaligned.
3. Once the proper drive chain tension has been achieved, tighten the axle nuts (clockwise).

### ⚠ CAUTION

**CHAIN MUST HAVE NO LESS THAN AND NO MORE THAN A 1/4" OF MOVEMENT.  
IF CHAIN IS TOO LOOSE, IT CAN JUMP OFF OR BREAK FROM THE DRIVE TRAIN AND CAUSE SERIOUS INJURY**

*The chain should be cleaned and lubricated with bicycle chain lubricant (available at local bike shops) after every 100 miles of riding (approx. ten rides) or after riding the SCOOT - N - GO™ in wet road conditions*

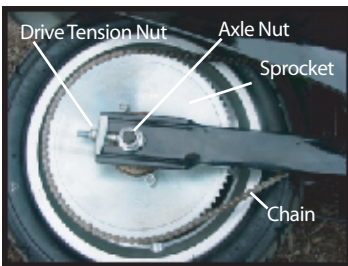

FIG 1

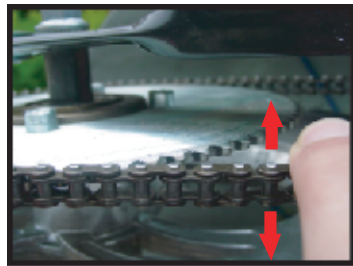
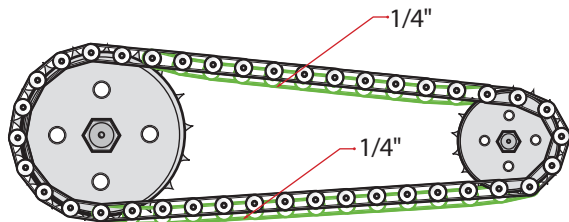

FIG 2

Drive Chain Requires  
No More & No Less Than  
1/4" Movement





# BATTERY

## ⚠ CAUTION

**BEFORE OPERATING YOUR NEW SCOOT - N - GO™ FOR THE FIRST TIME, THE BATTERY MUST BE FULLY CHARGED! FAILURE TO KEEP THE SCOOT - N - GO™ BATTERY CHARGED WILL CAUSE TOTAL BATTERY FAILURE. DO NOT ALLOW BATTERY TO BE FULLY DISCHARGED! ONCE CHARGER IS PROPERLY ATTACHED TO SCOOTER AND A SUFFICIENT POWER SOURCE, THE CHARGER INDICATOR LIGHT WILL FLASH INDICATING THE UNIT IS BEING PROPERLY CHARGED. ONCE FULLY CHARGED THE INDICATOR LIGHT WILL REMAIN GREEN**

Be sure to charge the SCOOT - N - GO™ after each use. Keeping the battery properly charged will help extend the battery life. The battery must be charged while installed in the SCOOT - N - GO™. If you notice anything unusual about the battery such as a cracked or leaking battery case, a battery that gets hot while being used or charged, a battery case that appears "puffy" or "bloated" etc, or there are any other problems with the battery, please contact Electra Customer Service / Technical Support Toll-Free at 1-888-467-1234 M-F 10am - 9pm EST. The battery is sealed and is NOT user serviceable. Do not attempt to repair, remove, adjust or in any way alter any internal or electrical components, controls or wiring without first speaking with a customer service representative.

## ⚠ CAUTION

**THE SCOOT - N - GO™ IS EQUIPPED WITH A 24V BATTERY CHARGER THAT WILL INTERRUPT THE CHARGING PROCESS ONCE THE BATTERY HAS RECEIVED A SUFFICIENT CHARGE.**

## CHARGING THE BATTERY

## ⚠ CAUTION

- **DO NOT CHARGE OR STORE THE SCOOT - N - GO™ CLOSER THAN 20 FEET FROM ANY FLAME (E.G. FURNACE, FIREPLACE, WATER HEATER, SPACE HEATER)**
- Be sure to only use 110V AC with the SCOOT - N - GO™ charger. Also make sure the plug is inserted into a three prong grounded AC outlet.
- PLUG the POWER INPUT CORD into the SCOOT - N - GO™ charging receptacle.
- Plug the SCOOT - N - GO™ 24V battery charger into a 110V AC power source.
- The CHARGER INDICATOR LIGHT will illuminate confirming that power is connected to the charger. If the light does not come on check all connections. If it still does not come on after checking all connections, fuses and that your AC plug is working, unplug the charger and call Electra Customer Service / Technical Support Toll-Free at 1-888-467-1234 M-F 10am - 9pm EST
- When the light on the 24V charger light is solid green, your SCOOT - N - GO™ is fully charged
- Disconnect the Input Cord from the Charging Receptacle.
- Disconnect the charger from the 110V Power Source.

## ⚠ WARNING ⚠ CAUTION

- **NEVER LEAVE THE BATTERY CHARGER CONNECTED TO THE 110V POWER SOURCE OR THE SCOOT - N - GO™ WHEN NOT CHARGING THE BATTERY. KEEPING THE CHARGER PLUGGED INTO THE 110V POWER SOURCE AND NOT THE BATTERY COULD CAUSE THE CHARGER TO OVERHEAT AND OR CAUSE A FIRE.**
- When storing your SCOOT - N - GO™ for lengthy periods of time, the battery should be charged at least once a month to avoid full battery depletion.

## ⚠ WARNING

**CALIFORNIA PROPOSITION 65  
BATTERY POSTS, TERMINALS, POWER CORDS AND BRAKE CABLES MAY CONTAIN LEAD AND LEAD COMPOUNDS, CHEMICALS KNOWN TO THE STATE OF CALIFORNIA TO CAUSE CANCER AND REPRODUCTIVE HARM. WASH HANDS AFTER HANDLING.**



## STARTING INSTRUCTIONS

1. Make sure you have READ ALL SAFETY GUIDELINES AND PRE-RIDE ADJUSTMENTS IN THIS MANUAL
2. Make sure battery is fully charged
3. Check brakes
4. Insert key in ignition and turn right
5. Check throttle
6. Check all lights
7. Rotate throttle to accelerate



## SERVICE & MAINTENANCE

### DRIVE CHAIN

*\*Refer to Pre-Ride Adjustments in this manual*

### BRAKES

*\*Refer to Pre-Ride Adjustments in this manual*

### FLAT TIRE REPAIR

To change a tire or inner tube, it is a good idea to keep the SCOOT - N - GO™ tool kit with you when you ride. You should also carry plastic "tire levers" (available at local bike shops), a spare inner tube that fit the wheel and tire size available from Electra at [www.electraUSA.com](http://www.electraUSA.com) or by calling Customer Service at 1-888-967-1234 M-F 10am-9pm EST as well as a manual hand pump to re-inflate the tire if you have a flat or it becomes low during use.

1. Depress the tire valve to let all the air out of the tube.
2. Remove the wheel from the scooter using the wrench provided or your own wrench. Loosen the nuts by turning counterclockwise. Be sure to remember where all the spacers and washers belong. For rear tire removal you will also need to slip the chain off the rear sprocket to remove the wheel. The chain must be properly reinstalled and re-tensioned when reinstalling the rear wheel. Make certain the chain is properly position on both front and rear sprockets before re-tightening rear wheel.
3. Remove one bead of the tire from the rim by grasping it at a point opposite the valve stem with both hands and, at the same time, lifting and peeling one side of the tire off the rim. If the bead is on too tight for you to unseat it with your hands use tire levers to lift the bead carefully over the tire rim. Tire levers can be purchased at any local bike shop. Push the valve stem through the wheel rim. Remove the inner tube.
4. Carefully check the outside and inside of the tire for the cause of the puncture and remove any debris or damaging material from the inside or outside of the tire.

Continued on Next Page

## SERVICE & MAINTENANCE

### **⚠️ WARNING**

**PATCHING A TUBE IS AN EMERGENCY REPAIR. CARELESS PATCHING OR APPLYING SEVERAL PATCHES CAN SERIOUSLY WEAKEN THE TUBE, RESULTING IN POSSIBLE TUBE FAILURE, WHICH COULD CAUSE YOU TO LOOSE CONTROL AND FALL. REPLACE A PATCHED TUBE AS SOON AS POSSIBLE.**

5. Reinstall the tire and tube. Slip one tire bead over the rim. Insert the valve stem through its hole in the rim. Feed the tube carefully into the cavity of the tire. Inflate the tube just enough to give it some shape. Starting at the valve stem and working around both sides of the rim to the side opposite the valve stem, use your thumbs to push and seat the other bead of the tire inside the rim. Be careful not to pinch the tube between the tire bead and the wheel rim. If you have trouble getting the last few inches of bead over the edge of the rim with thumb pressure, use a tire lever and be careful not to pinch the tube.

6. Check to make sure that the tire is evenly seated around both sides of the rim and that the tube is inside the tire beads. Push the valve stem into the tire to make sure that its base is seated within the tire's beads. Inflate the tube slowly to the recommended pressure on the tire sidewall. Check to make sure that the tire beads stay seated in the rim. Replace the valve cap. Replace the wheel in the scooter.

### **⚠️ WARNING ⚠️ CAUTION**

**RIDING YOUR SCOOT - N - GO™ WITH A CUT TIRE, FLAT OR UNDER- INFLATED TIRE CAN SERIOUSLY DAMAGE THE TIRE, RIM (WHEEL), TUBE, AND THE SCOOTER. IT MAY ALSO CAUSE YOU TO LOSE CONTROL AND FALL. IF YOU USE A SCREWDRIVER OR ANY TOOL OTHER THAN A TIRE LEVER, YOU ARE LIKELY TO PUNCTURE THE TUBE.** Replacement parts are able to be purchased by calling the Electra Customer Service at 1-888-967-1234 M-F 10am - 9pm EST or by visiting Electra's website at [www.electraUSA.com](http://www.electraUSA.com).

### **⚠️ WARNING**

**DO NOT USE GAS STATION AIR FILLING STATIONS AS THE PRESSURE IS USUALLY TOO HIGH AND THE GAUGES ARE INACCURATE. OVER INFLATION OF THE TIRE COULD CAUSE A BLOW OUT AND CRASH**

## BATTERY MAINTENANCE

*\*Refer to battery charging instructions*



### BATTERY RECYCLING



When maintained and used properly, (by following charging and storage guidelines), the Lead Acid Battery used in this product has a normal life span of many miles. When the battery no longer holds a charge or is unable to be charged properly, it should be removed from the SCOOT - N - GO™ and delivered to a recycling facility. State Laws prohibit disposal of lead-acid batteries in everyday trash. Please contact your local solid waste or recycling authority for recycling information in your area.

### STORING YOUR SCOOT - N - GO™

Proper storage preparation is essential for keeping your SCOOT - N - GO™ trouble free and in good working order. The following steps will help you keep rust and corrosion from impairing your SCOOT - N - GO™ functions and appearance.

### STORAGE PRECAUTIONS

- Select a well-ventilated storage area away from any heat, flames, such as a furnace, water heater, or clothes dryer.
- Avoid leaving your SCOOT - N - GO™ outside or in damp, moist areas to prevent rust and corrosion.
- Do not wash your SCOOT - N - GO™ with a hose or water. To clean your SCOOT - N - GO™ use a damp cloth to wipe dirt.
- Do not leave key in ignition.
- Keep Upright when storing

### REMOVING FROM LONG TERM STORAGE

After removing your SCOOT - N - GO™ from long term storage, go through the proper assembly steps and pre-ride adjustments. Make sure all bolts, nuts and fasteners are securely tightened. Check the drive chain tension and wheel bearings. Inspect entire unit for any rust or corrosion. Make sure there are no cuts or splits in the rubber tires. Following these steps will ensure a safe unit and fun riding experience.

# TROUBLE SHOOTING

If your SCOOT - N - GO™ sustains an impact:

## **⚠ WARNING**

**A CRASH OR OTHER IMPACT CAN PUT EXTRAORDINARY STRESS ON COMPONENTS, CAUSING THEM TO FATIGUE PREMATURELY. COMPONENTS SUFFERING FROM STRESS FATIGUE CAN FAIL SUDDENLY AND CATASTROPHICALLY, CAUSING LOSS OF CONTROL, SERIOUS INJURY OR DEATH.**

First, check yourself for injuries, and take care of them as best you can. Seek medical help if necessary. Next, if your SCOOT - N - GO™ is damaged, perform the checks described in this manual. If you are unable to fix any or all damage/problems, or if you find any bent, scored, or discolored parts, please call Electra Customer Service at 1-888-467-1234 M-F 10am - 9pm EST or visit the Electra website at [electraUSA.com](http://electraUSA.com) for replacement parts.

## **⚠ WARNING**

**IF YOU HAVE ANY DOUBT ABOUT THE CONDITION OF THE SCOOT - N - GO™ OR ANY OF ITS PARTS, CALL ELECTRA CUSTOMER SERVICE AT 1-888-467-1234 M-F 10AM - 9PM EST AND THEY WILL ASSIST YOU IN PERFORMING A THOROUGH CHECK.**

Problem	Possible Cause	Correction
1. Scooter motor does not run	<ol style="list-style-type: none"><li>1. Key ignition is in OFF position</li><li>2. Fuse has burned out/failed</li><li>3. Battery is undercharged</li></ol>	<ol style="list-style-type: none"><li>1. Rotate Key to ON position</li><li>2. Remove, inspect, and replace with additional fuses from tool kit</li><li>3. Charge the battery for a sufficient amount of time; replace battery</li></ol>
2. Scooter does not accelerate	<ol style="list-style-type: none"><li>1. Battery is undercharged or completely drained</li><li>2. Electric throttle is not attached or in need of repair</li><li>3. Drive chain has become unseated</li></ol>	<ol style="list-style-type: none"><li>1. Charge the battery for a sufficient amount of time; replace battery</li><li>2. Check all throttle connections and wiring; replace throttle if necessary</li><li>3. Reseat the drive chain on both sprockets and adjust tension</li></ol>
3. The actual driving range is shorter than the estimated range	<ol style="list-style-type: none"><li>1. The tires are under inflated</li><li>2. The battery is undercharged</li><li>3. Poor riding conditions</li><li>4. Weight of rider</li><li>5. Drive Chain</li></ol>	<ol style="list-style-type: none"><li>1. Inflate to 45-50 PSI</li><li>2. Charge the battery for a sufficient amount of time; replace battery</li><li>3. Do not ride in sand, ice, snow, or unstable riding areas</li><li>4. Mfg, suggest rider not exceed 178 lbs.</li><li>5. Adjust Drive chain tension</li></ol>

# REPLACEMENT PARTS

To order replacement and/or spare parts for your SCOOT - N - GO™, make sure you call the Electra Customer Service / Technical Support Toll-Free Number 1-888-467-1234 M-F 10am - 9pm EST or view the SCOOT - N - GO™ replacement parts available at [www.electraUSA.com](http://www.electraUSA.com).

# WIRING DIAGRAM

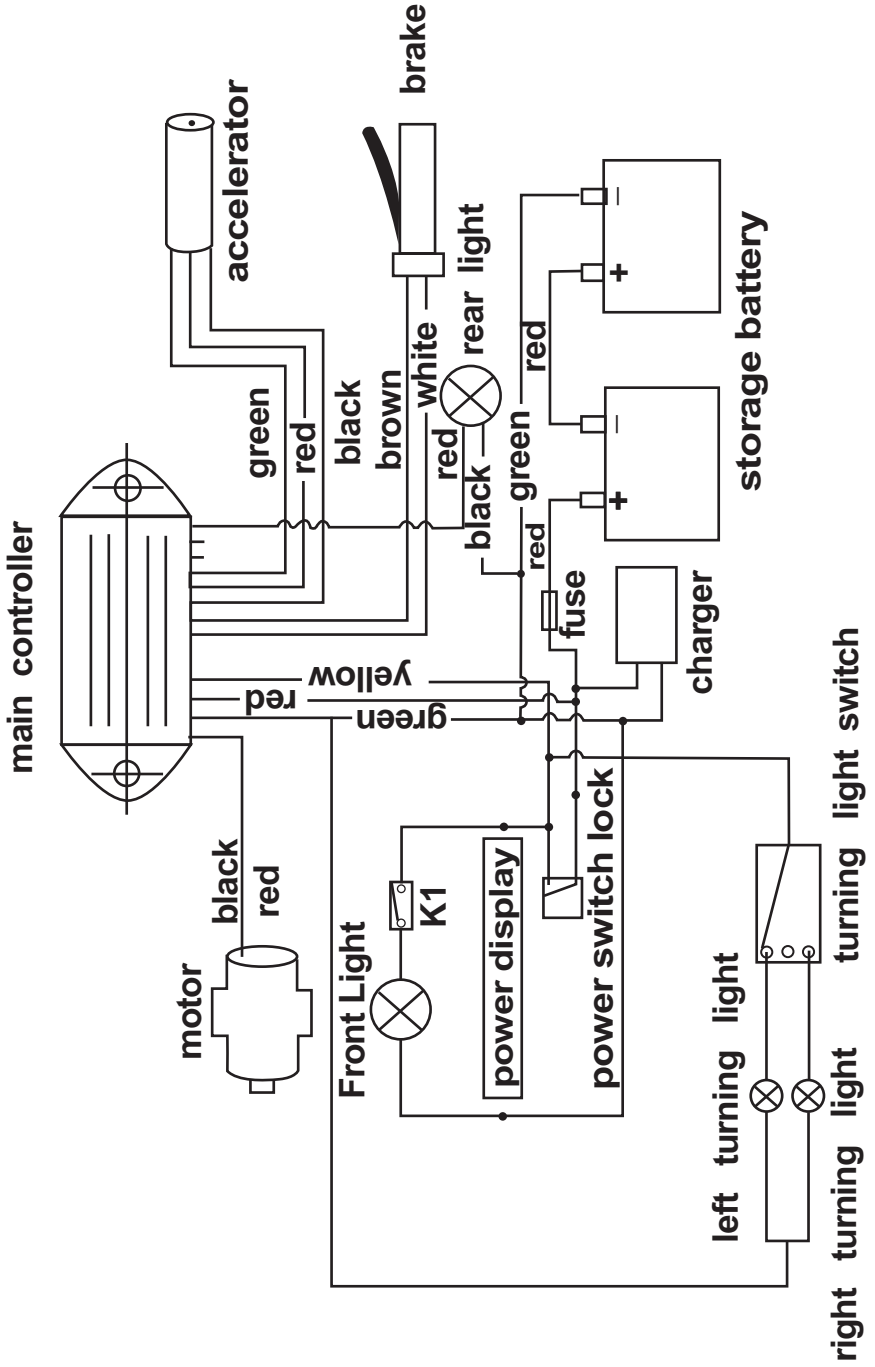

### 30 Day Limited Warranty

Electra Accessories, Inc. ("Electra" the distributor) warrants to the original retail purchaser ("you") that the Electra product for which this warranty has been issued is free from defects in material and workmanship for 30 days from the date of original retail purchase. This warranty is not transferable to a subsequent purchaser. Electra's sole obligation under this warranty is to repair or replace the product, at Electra's option. Electra must be notified in writing of any claim under this warranty within 15 days of any claimed lack of conformity of the product.

### Warranty Limitations

The duration of any implied warranty or condition, of merchantability, fitness for a particular purpose, or otherwise, on this product shall be limited to the duration of the express warranty set forth above. In no event shall Electra be liable for any loss, inconvenience or damage, whether direct, incidental, consequential or otherwise, resulting from breach of any express or implied warranty or condition, of merchantability, fitness for a particular purpose, or otherwise with respect to this product, except as set forth herein. Some states or countries do not allow limitation on how long an implied warranty lasts and some do not allow exclusions or limitations of incidental or consequential damages, so the above limitations or exclusions may not apply to you. This warranty gives you specific legal rights, and you may also have other rights, which may vary, from location to location. This warranty will be interpreted pursuant to the laws of the United States. The original English language version/meaning of this warranty controls over all translations and Electra is not responsible for any errors in translation of this warranty or any product instructions. This warranty is not intended to confer any additional legal, jurisdictional or warranty rights to you other than those set forth herein or required by law. If any portion of this warranty is held to be invalid or unenforceable for any reason, such finding will not invalidate any other provision. For products purchased in countries other than the United States please contact Electra's authorized distributor in that respective country.

# WARRANTY INFO

## Warranty Service Options

To obtain service under this warranty you must Call our Toll-Free Number at 1-888-467-1234 M-F 10am - 9pm EST for Customer Service/Technical Support on your Electra Product BEFORE returning your Electra Product back to the place of purchase. If you return your Electra Product for warranty service you must obtain a return authorization number by calling Electra at 1-888-467-1234 M-F 10am - 9pm EST. Send your Electra product (with the return authorization number on the outside of the shipping container and affixed to the product), together with the retail seller's original receipt or other satisfactory proof of the date of purchase to:

Electra Accessories Inc.  
2 Corporate Drive Cranbury, New Jersey 08512 USA  
[www.electraUSA.com](http://www.electraUSA.com) / [CustomerServiceNJ@ElectraUSA.com](mailto:CustomerServiceNJ@ElectraUSA.com)

THE ELECTRA PRODUCT MUST BE RETURNED IN ITS ORIGINAL BOX, ALONG WITH ALL KEYS, CHARGER, MIRRORS & LOCKS, FLOOR MATS, AND ANY OTHER ACCESSORIES THAT CAME WITH YOUR UNIT. DUE TO TRANSPORTATION AND RECLAMATION ISSUES, IF THE ELECTRA PRODUCT IS NOT IN THE ORIGINAL PACKAGE IT MAY NOT BE RETURNED UNDER ANY CIRCUMSTANCES.

Any postage, insurance or other shipping costs incurred in sending your Electra product for service under either option above is your responsibility. Electra will not be responsible for products lost or damaged in shipping.

For products purchased in countries other than the United States please contact Electra's authorized distributor in the country where the product was purchased. They can be found on our website at [www.electraUSA.com](http://www.electraUSA.com)

Warranty Exclusions are listed below:

- Retailers and sellers of Electra products are not authorized to modify this warranty in any way. It is your responsibility to regularly examine the product to determine the need for normal service or replacement. This warranty does not cover the following:
- Products that have been modified, neglected or poorly maintained, used for commercial purposes, misused or abused or involved in accidents.
- Damage occurring during shipment of the products (such claims must be presented directly to the shipper).
- Damage to products resulting from improper assembly or repair, the use or installation of parts or accessories not compatible with the original intended use of the product, or the failure to follow the product warnings and usage instructions.
- Damage or deterioration to the surface finish, aesthetics or appearance of the product.
- The labor required to remove and/or re-fit and re-adjust the item covered by this warranty.
- Normal wear to the product.
- Any products for which the consumer does not follow the warranty procedures outlined above.

For the current version of this warranty please visit our website at [www.electraUSA.com](http://www.electraUSA.com)

(© 6/27/04 Electra Accessories, Inc.)

# RETURN POLICY

## SCOOTER 10 DAY RETURN/EXCHANGE POLICY

**THIS WRITTEN POLICY SUPERCEDES ANY OTHER PREVIOUS POLICY, WRITTEN OR IMPLIED. THIS WARRANTY IS TO BE POSTED AT THE STORE LEVEL IN PLAIN SIGHT OF THE CONSUMER.**

ALL ELECTRA ACCESSORIES SCOOTER PRODUCTS PURCHASED AT RETAIL AFTER JUNE 30, 2004 ARE COVERED UNDER THIS 10 DAY RETURN POLICY

ALL ELECTRA ACCESSORIES SCOOTER PRODUCTS ARE EXCHANGEABLE OR RETURNABLE FOR ANY REASON TO THE RETAIL POINT OF PURCHASE, IF ACCOMPANIED BY A STORE RECEIPT, FOR A PERIOD OF TEN (10) DAYS FROM THE DATE OF PURCHASE. TO BE ELIGIBLE FOR RETURN OR EXCHANGE, ALL ELECTRA ACCESSORIES SCOOTER PRODUCTS MUST BE IN LIKE NEW CONDITION, IN THE ORIGINAL BOX, ALONG WITH ALL ACCESSORIES THAT INCLUDE, BUT IS NOT LIMITED TO, KEYS, MIRRORS, TOOL KITS, LOCKS, MANUALS, FUSES, CHARGERS, ETC. ALL SCOOTER PRODUCTS MUST HAVE THE KEYS REMOVED FROM THE KEY SLOT AND ATTACHED WITH A ZIP TIE TO THE HANDLE BARS, THE FUSE REMOVED, AND THE BATTERY DISCONNECTED EITHER BY THE QUICK DISCONNECT, OR BY REMOVING THE BATTERY LEADS AND COVERING THE TERMINALS WITH TAPE. IN COMPLIANCE WITH FEDERAL REGULATIONS, IF THE RETURNED UNIT IS GAS, THE FUEL MUST BE DRAINED FROM THE TANK, AND THE FUEL LINES IN SUCH A WAY AS TO PROTECT THE ENVIRONMENT FROM CONTAMINATING SOIL OR WATER RESOURCES. GAS SCOOTER PRODUCTS THAT ARE RETURNED TO THE RETAIL POINT OF PURCHASE WITH FUEL IN THE TANK, OR IN THE FUEL LINES, ARE NOT ELIGIBLE FOR RETURN OR EXCHANGE.

DURING THE TEN (10) DAY RETURN/EXCHANGE PERIOD, ALL ELECTRA ACCESSORIES SCOOTER PRODUCTS ARE ALSO COVERED BY A THIRTY (30) DAY WARRANTY ON PARTS. THE WARRANTY DOES NOT COVER THE COST OF LABOR ON ANY SCOOTER PRODUCT FOR ANY REASON. THE CURRENT 30 DAY WARRANTY IS AVAILABLE ON THE INTERNET BY VISITING [WWW.ELECTRAUSA.COM](http://WWW.ELECTRAUSA.COM) OR BY CALLING THE ELECTRA ACCESSORIES TOLL FREE CUSTOMER SUPPORT NUMBER AT (888) 467-1234.

AFTER THE THIRTY (30) DAY WARRANTY, REPLACEMENT PARTS MAY BE PURCHASED ON THE INTERNET BY VISITING [WWW.ELECTRAUSA.COM](http://WWW.ELECTRAUSA.COM) OR BY CALLING THE ELECTRA ACCESSORIES TOLL FREE CUSTOMER SUPPORT NUMBER AT (888) 467-1234. CUSTOMERS ARE RESPONSIBLE FOR THE COST OF THE PART(S) NEEDED, AND ANY APPLICABLE UPS, FED EX, OR USPS SHIPPING CHARGES THAT APPLY. .

ELECTRA OR THE RETAIL STORE MAY REFUSE ANY RETURN OR EXCHANGE IF THE SCOOTER PRODUCT IN QUESTION APPEARS TO HAVE BEEN NEGLECTED BY THE OWNER OR IF THE SCOOTER PRODUCT HAS BEEN DAMAGED OR IF THE CONSUMER FAILED TO COMPLY WITH THE WRITTEN INSTRUCTION MANUAL, THIS 10 DAY RETURN POLICY OR THE ELECTRA 30 DAY WARRANTY TERMS. RETAILERS AND SELLERS OF ELECTRA PRODUCTS ARE NOT AUTHORIZED TO MODIFY THIS RETURN/EXCHANGE POLICY OR WARRANTY IN ANY WAY.



